

斗六廠
雲林縣斗六市斗工六路36號

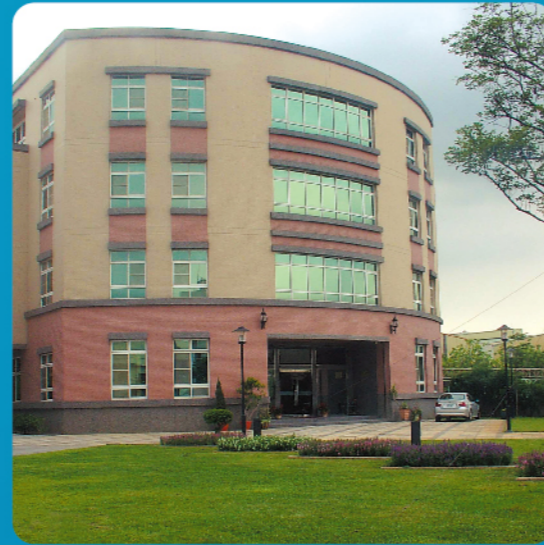

嘉義廠
嘉義縣民雄工業區成功街18號



40755台中市西屯區朝馬路152號
No.152, Chaoma Rd., Xitun Dist., Taichung City 407, Taiwan
TEL:886-4-22521450 FAX:886-4-22521447
E-mail:heng-yen@umail.hinet.net www.hengyen.com.tw

昆山琬晏電子科技有限公司
KUN SHAN GUANG YAN ELECTRONICS TECHNOLOGY CO., LTD.
江蘇省昆山市張浦鎮俱進路578號

惠州光晏復材科技有限公司
HUIZHOU KUANG YEN COMPOSITES TECHNOLOGY CO., LTD.
廣東省惠州市惠城區水口街道合生國際新城B1-23A
TEL :752-7212630 FAX:752-7212637



YOUR BEST PARTNER

完美接著 · 首選亨晏 www.hengyen.com.tw

我們是專業的電子、工業接著劑材料商，
提供專業、全方位的膠材服務，為您提供即時且系統性的解決方案



本公司產品通過 **SGS** 檢驗，
符合最新歐盟 ROHS&REACH 環保法規

我們服務的企業涵蓋：
自行車及運動器材產業/手工具產業/工具機及產業機械/汽車電子及電機產業/光學通訊及3C產業/家電產業... 等

碳纖維複材產業



▲ 預浸樹脂

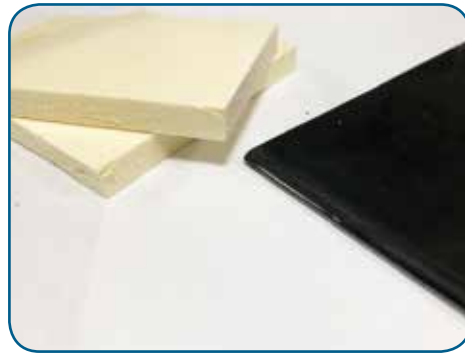

▲ 環氧型發泡樹脂



▲ 接著片膠

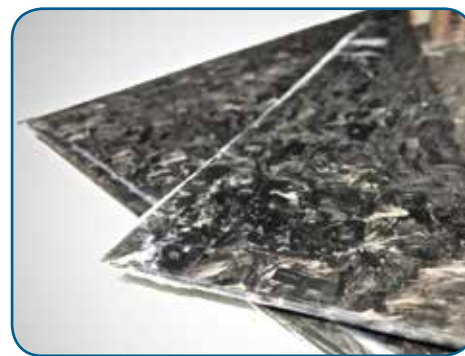

▲ 團狀、片狀預浸成型材料 (BMC、SMC)



▲ 表面處理劑



▲ UV 補土



▲ 雙液型高性能接著劑



▲ 單液型高性能接著劑

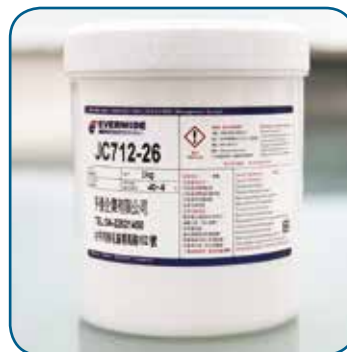

▲ 單液型補土

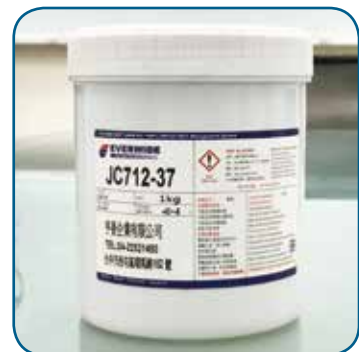

▲ 模內補土

電機產業應用

▶ 產業類別分為微電機，中型，重型電機應用

微電機類



重電機類



成功導入應用客戶群

馬達	散熱風扇	深水幫浦	超聲波	電磁制動器	變壓器	電感	壓電陶瓷
賜福 台達 倉興達 東盛	奇鋁 永立 建準	奇宏	康得森	仟岱 研新 瑞迪	乾坤 西北 台慶	精業 英達德	攀特



▲ 無刷馬達產業，磁鐵與主體表貼及嵌入接著



▲ 深水馬達灌注應用，耐高、低溫，耐水氣侵蝕、鹽霧侵蝕



▲ 超聲波震盪器震頭固定接著

▶ 成功導入使用於汽車產業的應用有：



汽車光電 LED 懸掛式燈組的灌注及上下殼體接著環氧

產品型號 /JA331AB 系列環氧樹脂

- ▶ 對 PC 燈殼與 ABS 主體接著良好，可以承受冷熱衝擊熱脹冷縮的應力，不會有龜裂。
- ▶ PC 燈殼內套入鑲滿 LED 燈珠電路板後，灌注雙組份環氧，可將 PVC,CGVC 電線固定，並且能承受拉扯力不鬆脫裂開，達到完全密封不漏水。
- ▶ 膠材的耐候性非常好，
可以承受： $-40^{\circ}\text{C} * 500\text{hr}$, $100^{\circ}\text{C} * 500\text{hr}$, $-40^{\circ}\text{C} \sim 85^{\circ}\text{C} * 240$ 次, $85^{\circ}\text{C} * 85\% \text{RH} * 240\text{hr}$



汽車安全系統無線訊號傳遞的胎壓感測模組

產品型號 /JC433AB 系列環氧樹脂

- ▶ 對 PA 加上玻纖機殼有很好的附著力，且固化後低殘留應力是最大特色。
- ▶ 膠體灌注後可以讓無線電波傳遞更加順暢。
- ▶ 膠材耐候性非常好，可以承受高溫高濕的輪胎內環境，更可以承受高速離心力的彎折而不龜裂。



汽車安全系統倒車影像感測雷達模組灌注

產品型號 /JB007AB 系列



電動汽車電池系統控制單元灌注應用

產品型號 /JA293AB 系列、UL 規格產品



汽車用震動波感應晶片模組封裝應用

FS 溼氣硬化型接著劑應用

MS 樹脂是一種具彈性，透明性，抗油和耐磨損的聚醚類樹脂。
MS 樹脂的特點如下：

- ▶ 優良耐磨性
- ▶ 優良機械性能
- ▶ 具橡膠狀彈性
- ▶ 高彈性
- ▶ 良好抗油性
- ▶ 優越耐低溫性能
- ▶ 高剪切強度
- ▶ 高透明度

▶ 產品應用實績：

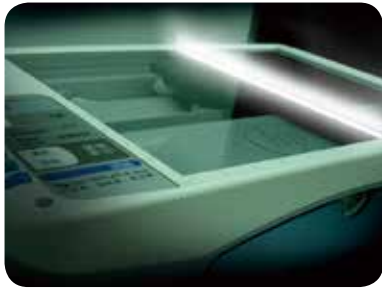

▲ 光學感測元件填縫接著固定應用



▲ 電子連接線組出線口接著固定防水密封應用



▲ 照明塑膠與金屬接著應用



▲ 工業鈍化金屬與塑膠接著應用

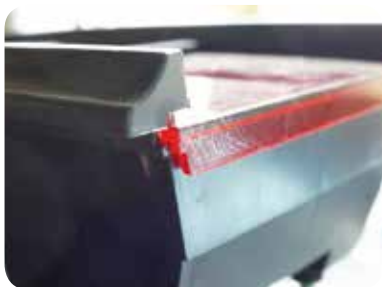

▲ 汽機車燈具防水接著密封應用



▲ 建築金屬結構件密封防水應用

LED 前後製程段封裝材料

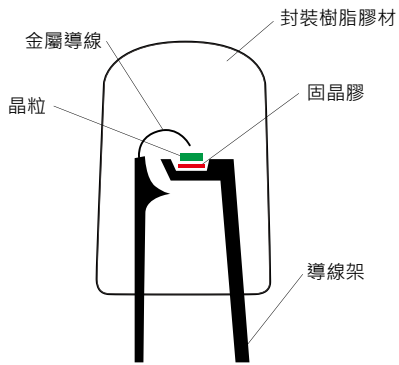

▲ LED 固晶膠

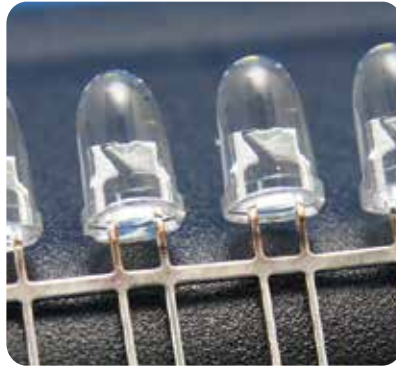

▲ 砲彈型 LED 外封裝膠



▲ LED 條燈灌封膠

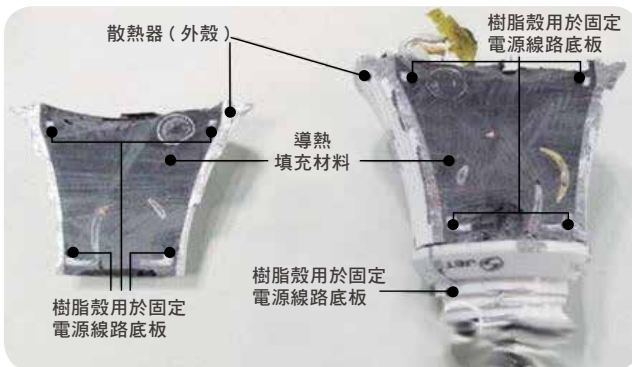

▲ 燈殼，螺旋後蓋與主體接著



太陽能封裝應用材料

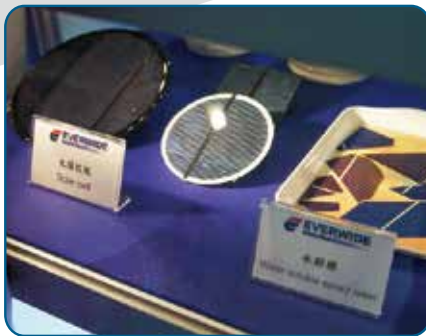

▲ 太陽能面板切割水解膠



▲ 太陽能面板鋁框封裝膠

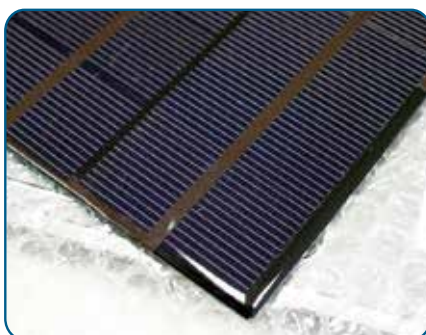

▲ 太陽能板灌封膠



SMT 貼片膠

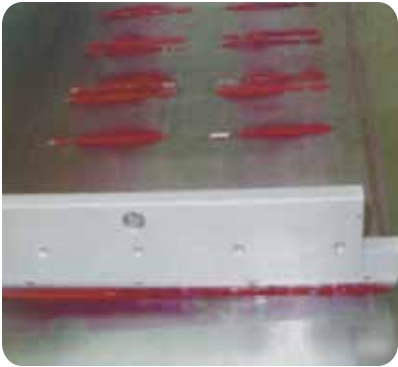

▲ SMT 貼片紅膠 - - 網印製程

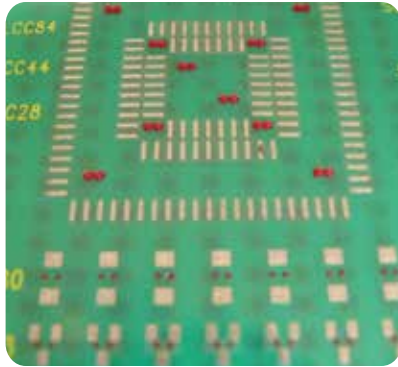

▲ SMT 貼片紅膠 - - 點膠用
(無鉛製程) 中速機

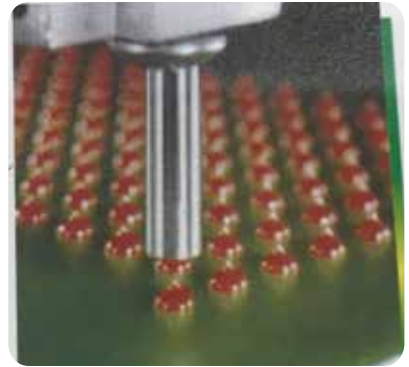

▲ SMT 貼片紅膠 - - 點膠用
(無鉛製程) 高速機

微型揚聲器應用膠材

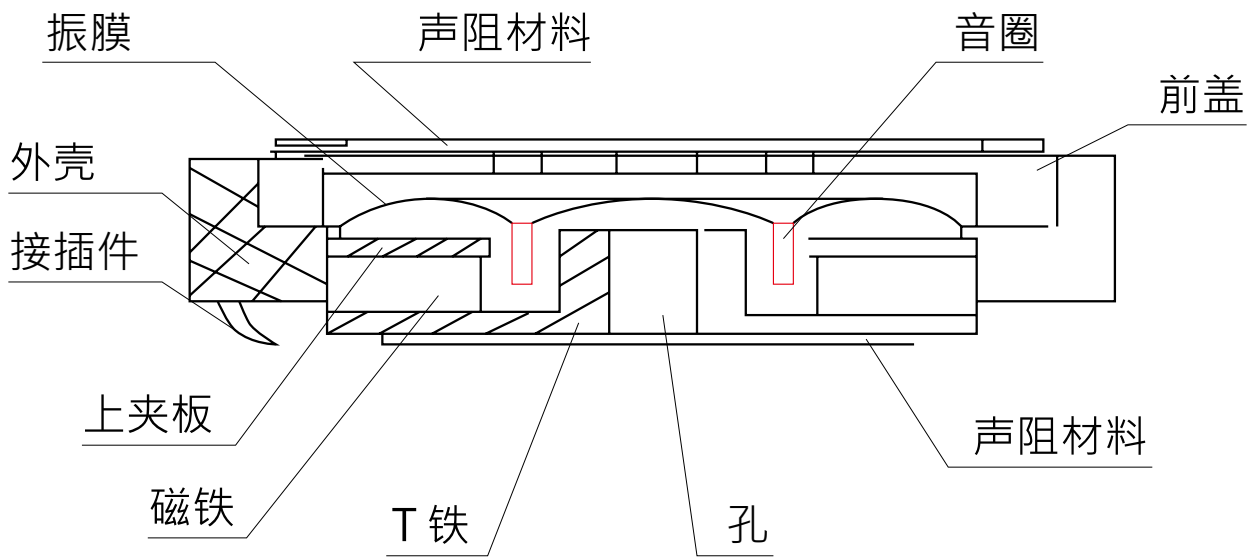

▲ 音圈、音膜與各種材質音膜黏接



▲ 磁缸與各種材質外框黏接、
磁缸與強力磁鐵黏接



▲ 焊接線補強應用

高性能瞬間膠

產品特點：高強度·耐溫佳，耐候性佳，可耐長期戶外之環境

Property : High adhesion strength, good weather resistance, long-term outdoor environmental resistance.



產品編號 Product No.	顏色 Color	規格 Type	黏度 (CPS)	硬化速度 CureSpeed	填補間隙 (毫米) GapFill (mm)	剪切強度 (kgf/cm ²) Shear Strengthtensile	比重 Specific- Gravity	溫度範圍 Temperature range (°C)	儲存條件 Storage condition
泛用型 All Purpose Series									
102	透明液體 CLEAR LIQUID	乙基 ETHYL	2-5	快 FAST	0.0508	210	1.05	-50°C~80°C	5°C
401	透明液體 CLEAR LIQUID	乙基 ETHYL	75-125	中 MEDIUM	0.127	220	1.05	-50°C~80°C	5°C
412	透明液體 CLEAR LIQUID	乙基 ETHYL	1200- 1500	中 - 慢 MEDIUMSLOW	0.2032	220	1.08	-50°C~80°C	5°C
909	透明膠狀 CLEAR GEL	乙基 ETHYL	膠狀 GEL	中 MEDIUM	0.254	220	1.06	-50°C~80°C	5°C
無氣味低白霧系列 Low Odor,Low Bllooming Series									
202	透明液體 CLEAR LIQUID	甲氧基 ALKOXY- ALKYL	40-80	中 MEDIUM	0.1016	190	1.10	-50°C~70°C	5°C
212	透明液體 CLEAR LIQUID	甲氧基 ALKOXY- ALKYL	1200- 1500	慢 SLOW	2.794	180	1.10	-50°C~70°C	5°C
金屬接著系列 Metal Series									
703	透明液體 CLEAR LIQUID	甲基 METHYL	100- 200	中 MEDIUM	0.1524	250	1.08	-50°C~80°C	5°C
耐衝擊韌性佳系列 Rubber Toughened Series									
C681	透明液體 CLEAR LIQUID	乙基 ETHYL	1000- 2000	中 MEDIUM	0.2032	210	1.07	-50°C~100°C	5°C
C685	透明液體 CLEAR LIQUID	乙基 ETHYL	4000- 7000	慢 SLOW	0.2032	220	1.07	-50°C~100°C	5°C
B680	黑色液體 BLACK LIQUID	乙基 ETHYL	500- 1000	快 FAST	0.1524	250	1.10	-50°C~100°C	5°C
B684	黑色液體 BLACK LIQUID	乙基 ETHYL	4000- 7000	中 MEDIUM	0.2032	250	1.08	-50°C~100°C	5°C
不活化表面系列 Surface Insensitive Series									
601	透明液體 CLEAR LIQUID	乙基 ETHYL	100-200	快 FAST	0.127	220	1.05	-50°C~80°C	5°C
695	透明液體 CLEAR LIQUID	乙基 ETHYL	40-80	快 FAST	0.1016	210	1.05	-50°C~80°C	5°C

專業表面處理劑與加速劑系列

MXBON 處理劑系列產品，是因應各種不同材質與製程，所搭配的專用產品。



螺絲固定劑

產品特點：高強度·耐溫佳，耐候性佳

Property : High adhesion strength, weather resistance.



產品編號 Product No.	顏色 Color	規格 Type	黏度 (CPS)	硬化速度 CureSpeed	填補間隙 (毫米)	剪切強度 (kgf/cm ²)
22	小於 M20 螺絲 可拆卸 M20 Below Removable	1,200~5,000	15	8	4	-54°C~150°C
42	小於 M20 螺絲 可拆卸 M20 Below Removable	1,200~5,000	10~15	17	5	-54°C~150°C
43	小於 M20 螺絲 可拆卸 M20 Below Removable	1,200~3,000	10~15	20	7	-54°C~150°C
62	小於 M25 螺絲 永久固定 M25 Below	1,200~2,400	15	22	10	-54°C~150°C
71	小於 M25 螺絲 永久固定 M25 Below	400~600	15	26	36	-54°C~150°C
72	小於 M36 螺絲 永久固定 M36 Below	6,000~10,000	15~30	20	30	-54°C~230°C
77	小於 M36 螺絲 永久固定 M36 Below	6,000~8,000	40	32	32	-54°C~150°C
90	小於 M12 螺絲 永久固定 M2~M12 Below	20~70	10~15	7	30	-54°C~200°C

圓形配件固定劑

產品特點：高強度·耐溫佳，耐候性佳

Property : High adhesion strength,
weather resistance



產品編號 Product No.	特色用途 Usage	黏度 Viscosity	硬化速度 (分) Cure speed (min)	填補間隙 Cap Fill (mm)	摩擦扭矩 Shear Strength (N.m)	溫度範圍 Working temperature
01	低黏度 Low Viscosity	100~150	10~15	0.05	>15	-54°C~150°C
20	耐高溫 High Temperature	5,000~12,000	10~15	0.38	>17	-54°C~200°C
48	適用於緊配件 Press Fit	400~600	10~15	0.15	>25	-54°C~150°C
38	適用於滑配件 Slip Fit	2,000~3,000	10~15	0.25	>25	-54°C~150°C
80	適用於滑配件 Slip Fit	1,200~2,000	15	0.4	>19.3	-54°C~150°C

自動化點膠、UV 設備



數位定量點膠機



智慧型視覺三軸點膠機



數位雙環旋轉平台點膠機



全數位蠕動式點膠機



全數位螺桿式點膠機



恆溫加熱控制點膠機



真空脫泡機



分離式 UV 硬化光罩系統

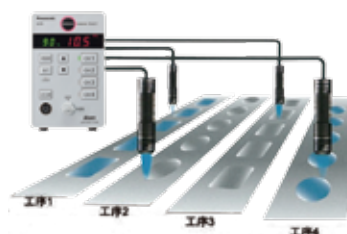

UV LED 點光源機



輸送帶式 UV 乾燥機



點光源 UV 機



抽屜式 UV 乾燥機

自動化點膠設備、配件及耗材

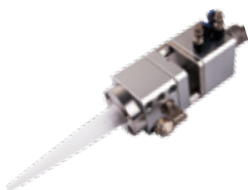

大流量柱塞式膠閥

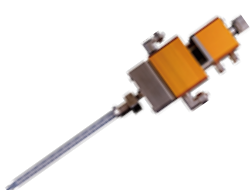

大流量雙液膠閥

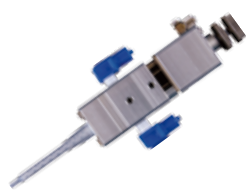

小流量雙液膠閥



雙液膠閥



隔膜式膠閥



柱塞式膠閥



330G 卡式膠閥



針筒



卡式膠筒



手控開關



各式特殊轉接頭



針筒套頭組件



不鏽鋼針頭



針頭

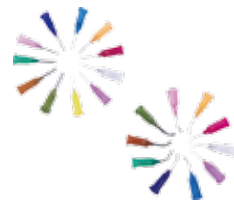

雙螺紋金屬針頭